

ATENCIÓN: Schuller recomienda que utilice los balancines suministrados en la instalación de este plafón.

**NOTA**

Incline ligeramente el difusor (1) de la pantalla para montarlo

Para ver la ficha técnica de producto completa, puede usar el siguiente código QR:

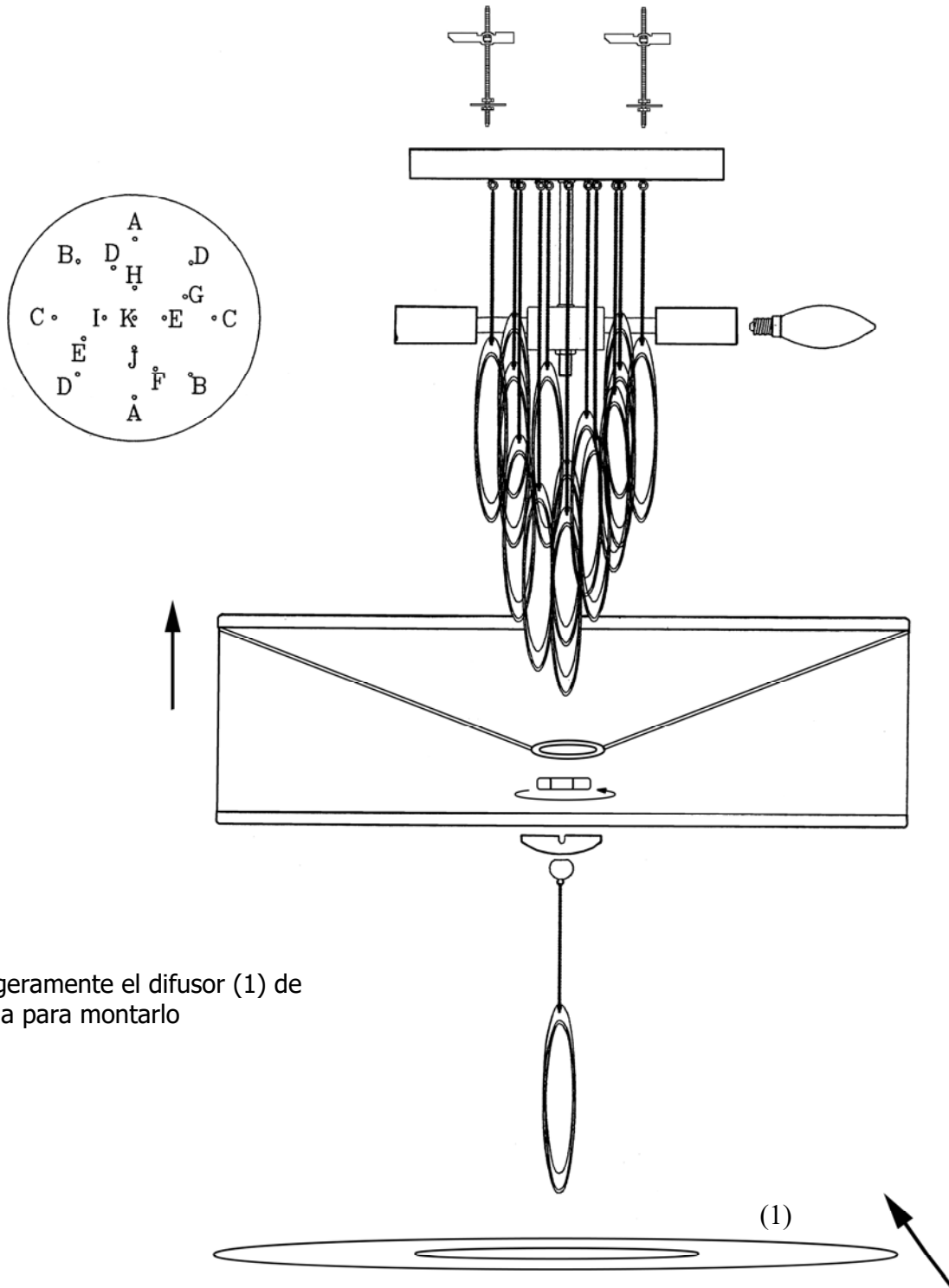

Para cualquier duda técnica pongase en contacto con nuestro Departamento Técnico.

Estamos a su servicio en nuestro email irodriguez@schuller.es o en nuestro teléfono 961 601 051 Ext. 229

Rev.04.22

Medidas de los diferentes colgantes de los plafones con referencias: 69441581

A

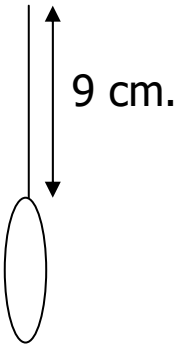

B

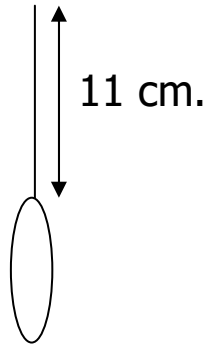

C

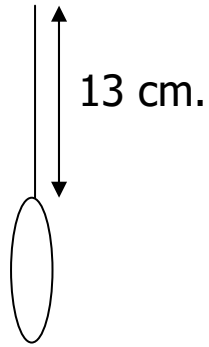

D

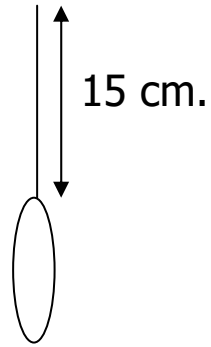

E

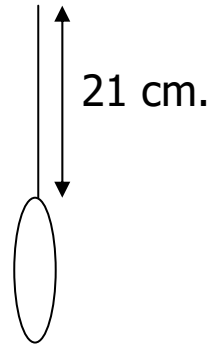

F

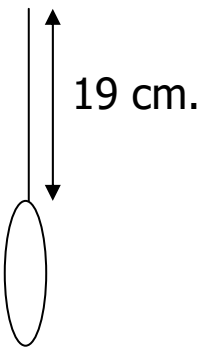

G

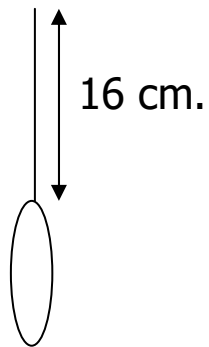

H

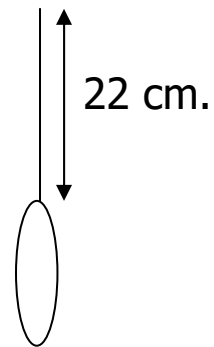

I

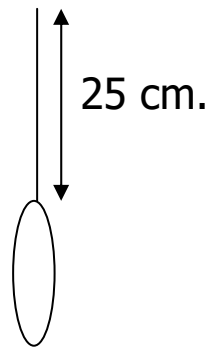

J

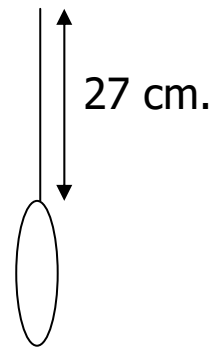

K

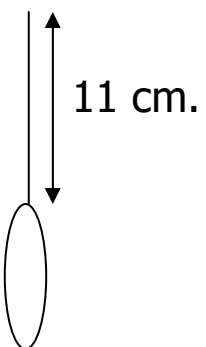

CAUTION: Schuller recommends to use included special screws when installing this ceiling lamp.

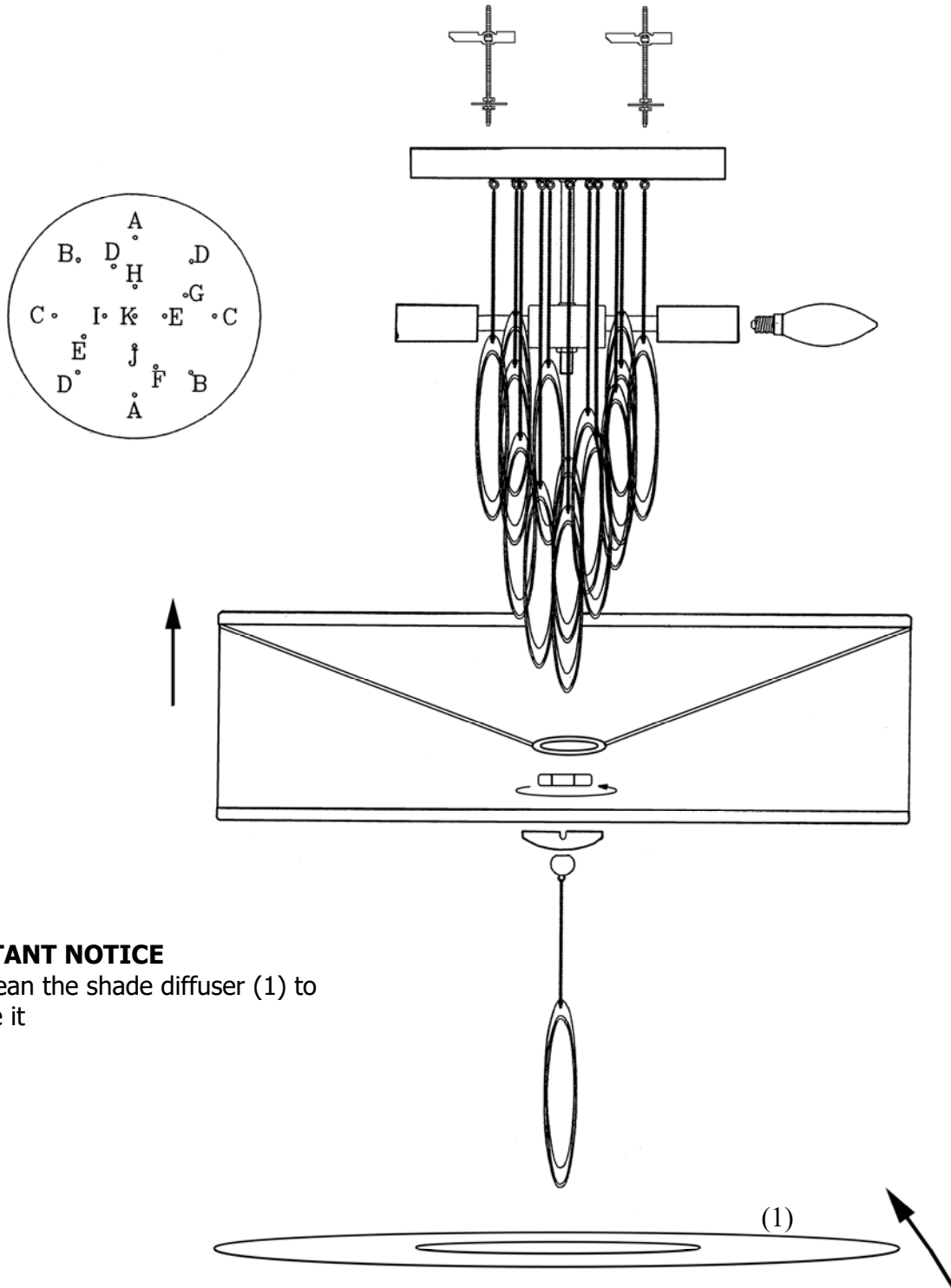

IMPORTANT NOTICE

Slightly lean the shade diffuser (1) to assemble it

You may use the following QR code to view the complete technical data sheet of the product:



If you have any technical questions, please do not hesitate to contact our technical Department. We are at your disposal in our email: irodriguez@schuller.es

Pendant ceiling lamp sizes. Item number 69441581

A

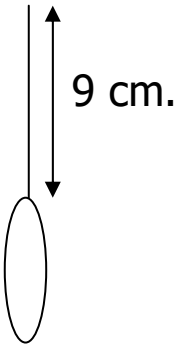

B

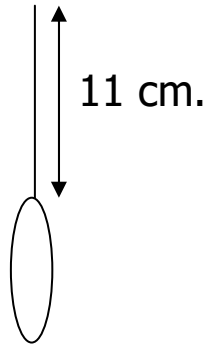

C

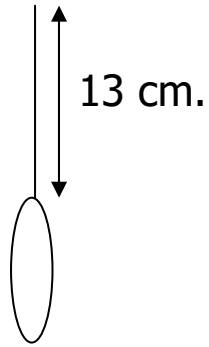

D

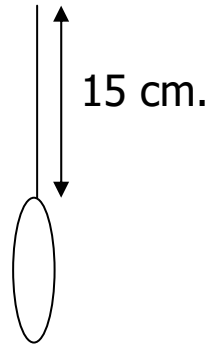

E

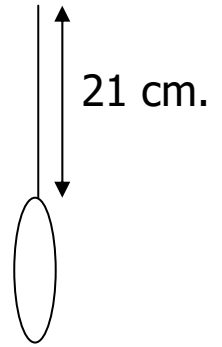

F

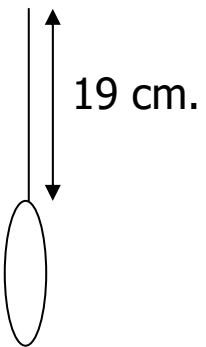

G

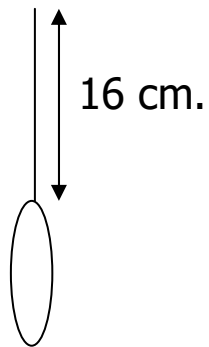

H

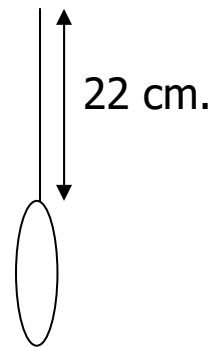

I

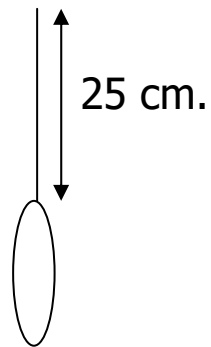

J

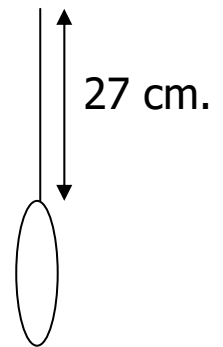

K

