

ATENCIÓN: Schuller recomienda que utilice los balancines suministrados en la instalación de esta lámpara.

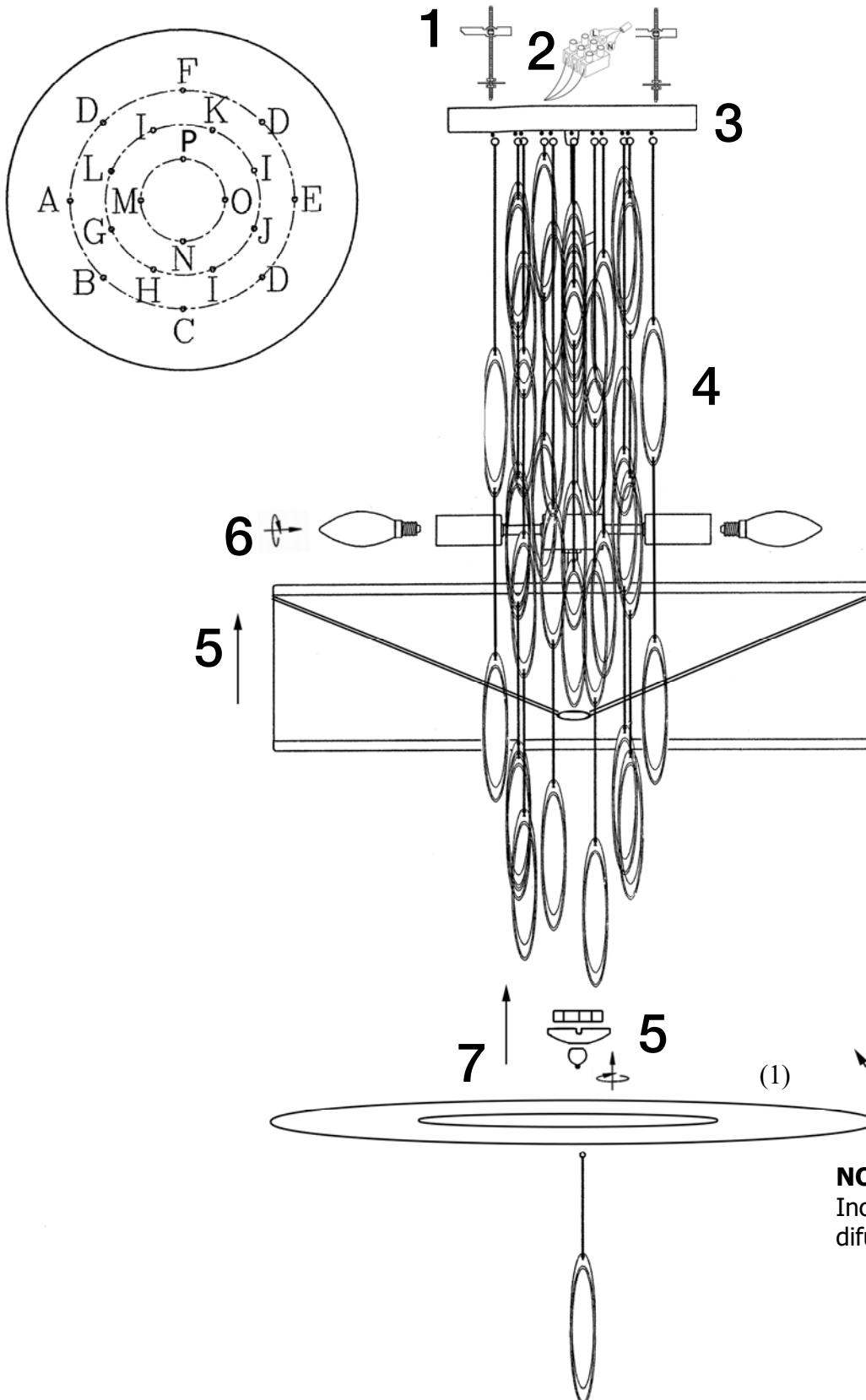

NOTA
 Incline ligeramente el difusor (1) para montarlo

Para ver la ficha técnica de producto completa, puede usar el siguiente código QR:



Cantidades y medidas de los diferentes colgantes de la lámpara modelo: 49441583

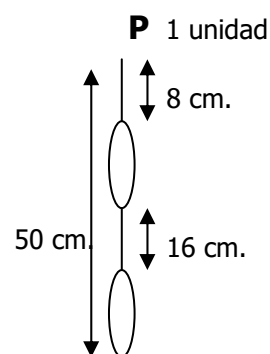
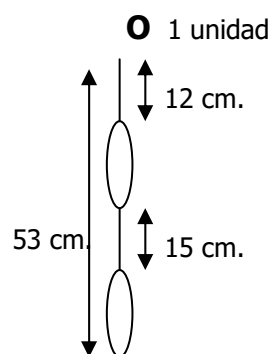
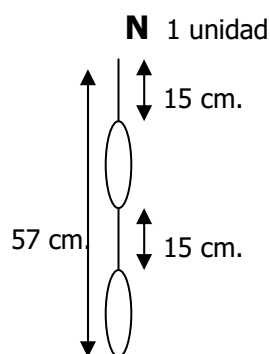
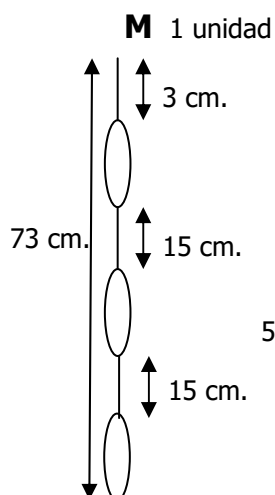
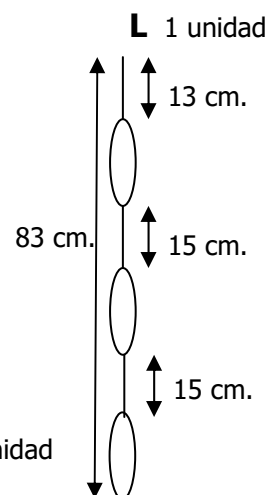
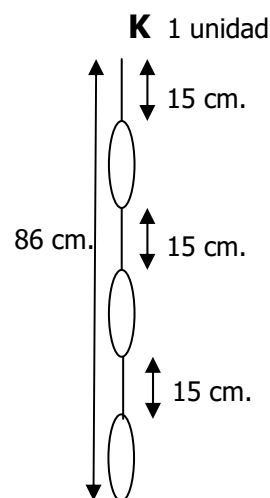
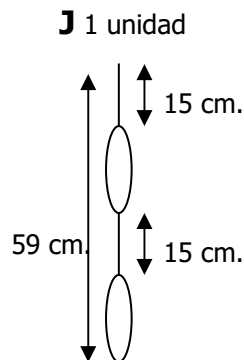
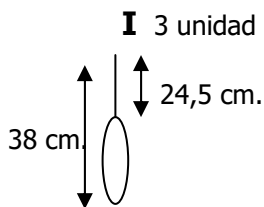
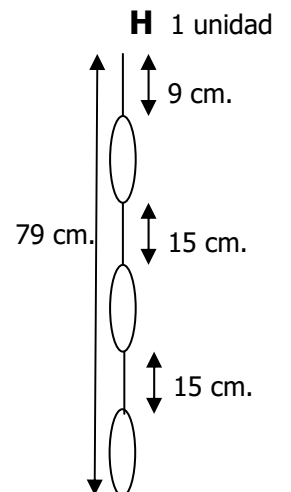
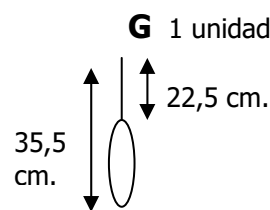
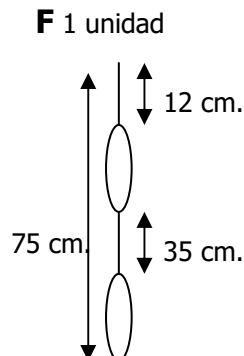
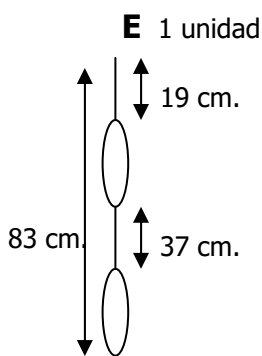
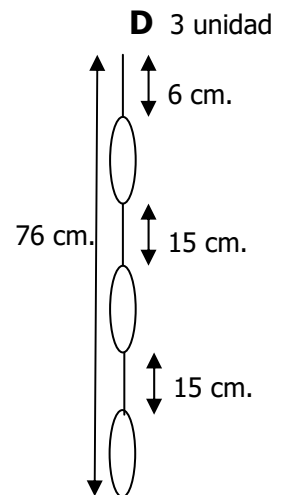
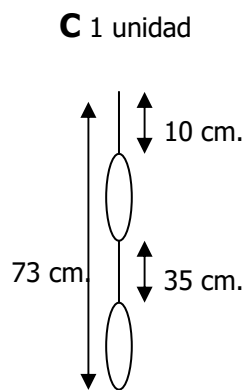
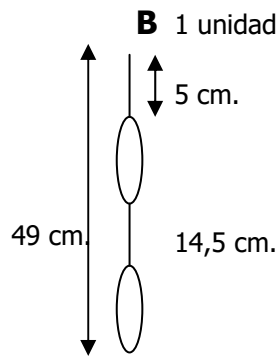
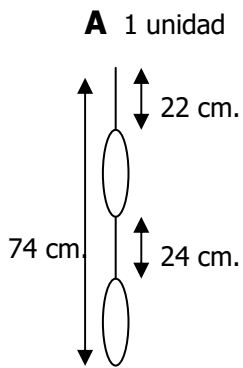

CAUTION: Schuller recommends to use included special screws when installing this lamp.

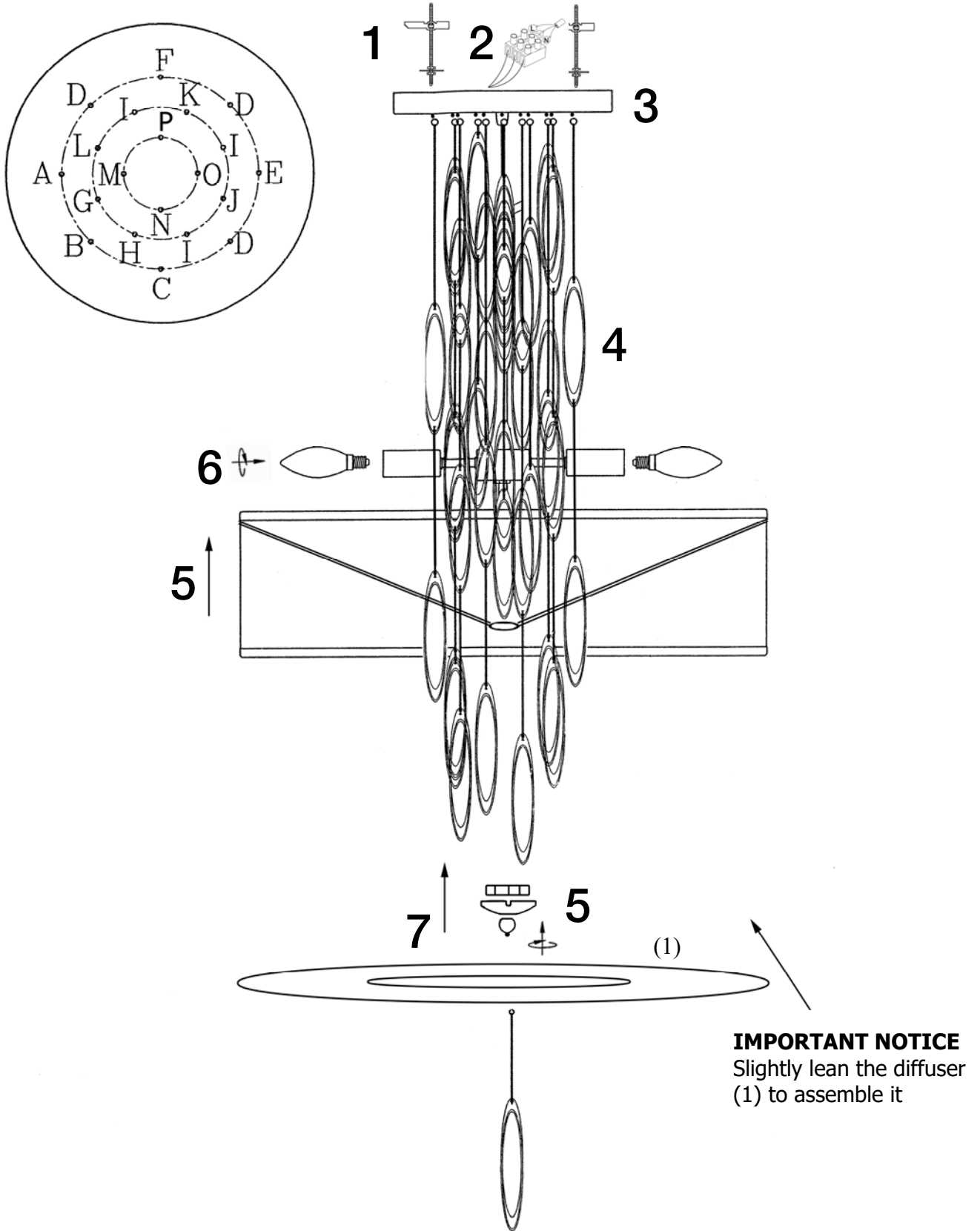

You may use the following QR code to view the complete technical data sheet of the product:



If you have any technical questions, please do not hesitate to contact our technical Department.
 We are at your disposal in our email: irodriguez@schuller.es

Pendant lamp sizes. Item number 49441583

A 1 unidad

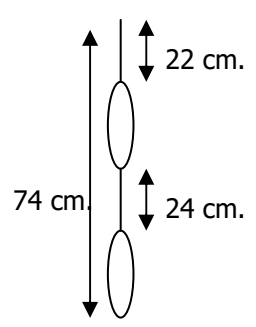

B 1 unidad

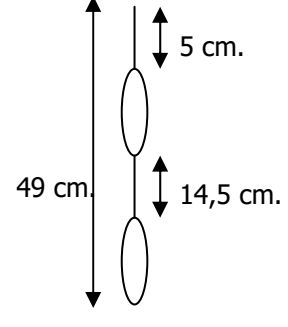

C 1 unidad

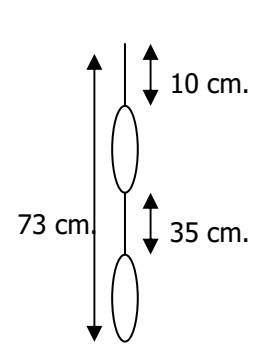

D 3 unidad

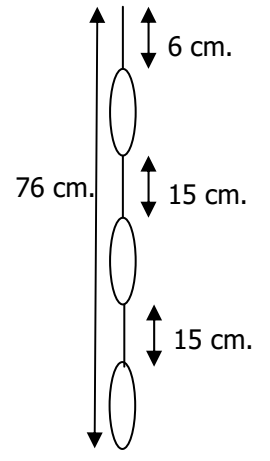

E 1 unidad

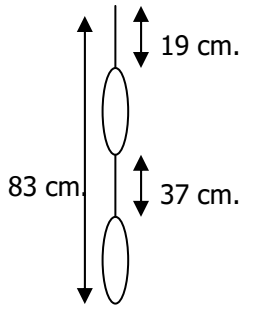

F 1 unidad

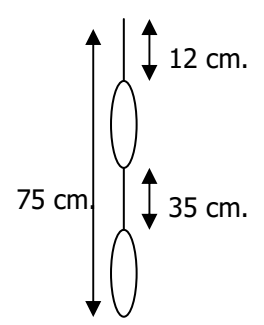

G 1 unidad

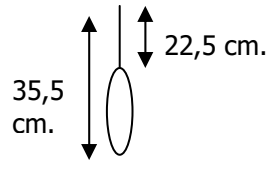

H 1 unidad

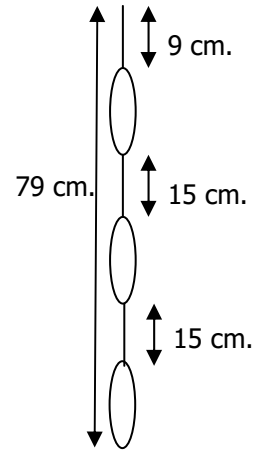

I 3 unidad

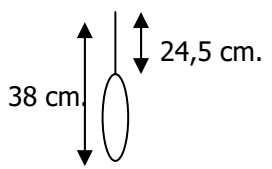

J 1 unidad

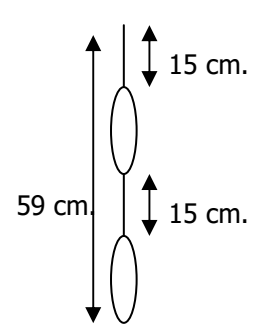

K 1 unidad

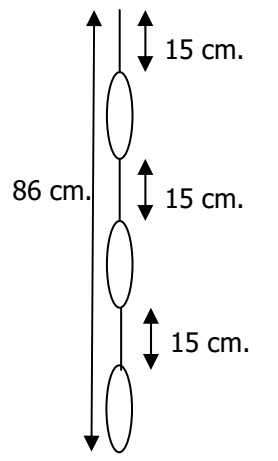

L 1 unidad

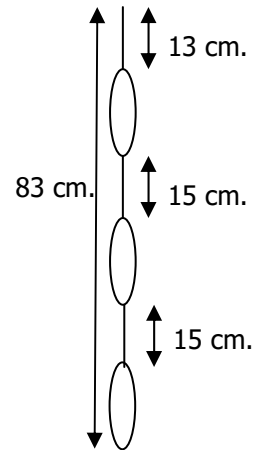

M 1 unidad

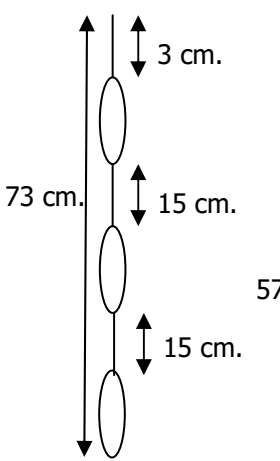

N 1 unidad

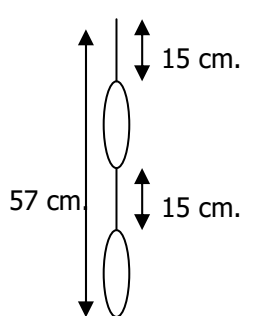

O 1 unidad

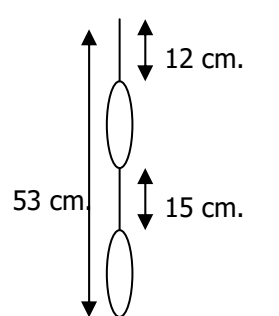

P 1 unidad

