

QUICK 28W CRI80 30° ON-OFF

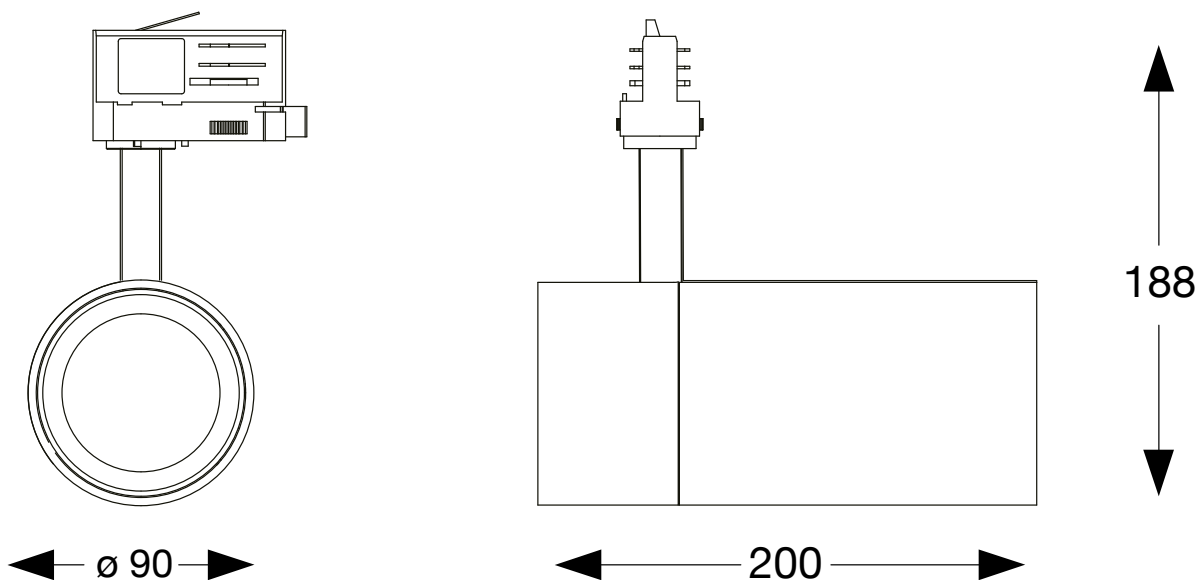

28W



3000 K
3000 K
4000 K
4000 K

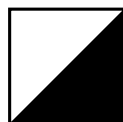

BLACK
WHITE
BLACK
WHITE



222622
222615
222646
222639

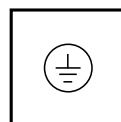

220-240
V AC
50/60 Hz

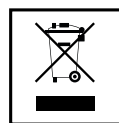
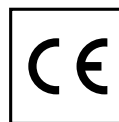

L'INSTALLAZIONE DI QUESTO APPARECCHIO DEVE ESSERE EFFETTUATA DA PERSONALE QUALIFICATO
THE LIGHTING FITTING SHOULD BE INSTALLED BY A QUALIFIED ELECTRICIAN



I connettori sono nascosti all'interno
Connectors are hidden inside



1

Assicurarsi che la leva sia posizionata lateralmente in modo che i connettori siano nascosti.
Make sure the lever is positioned sideways so that the connectors are hidden.



2

Inserire i connettori nel binario come illustrato.
Plug the connectors into the track as illustrated.



3

Attenzione, accertarsi del corretto posizionamento dell'articolo durante l'installazione come illustrato nell'immagine.
Warning, make sure to install the item in the correct position as illustrated.

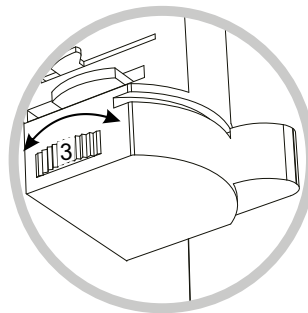
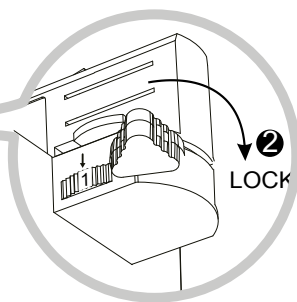

4

Ruotare la leva dei connettori di 90° come illustrato e bloccare il faretto. Selezionare la fase desiderata.
Turn the connectors' lever 90° according to the illustrated direction and lock the light. Select the chosen phase.

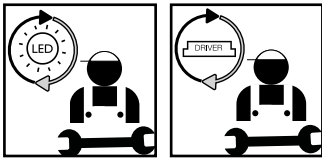

Questo prodotto contiene una sorgente luminosa di classe di efficienza energetica / This product is provided with a light source with efficiency energy class of:

EAN	Modello Sorgente Luminosa /Light Source Model	Classe di Efficienza Energetica / Energy Efficiency Class	Sorgente Luminosa / Light Source (mA)	Sorgente Luminosa / Light Source (V)
8021696222622	QUICK 28W CRI80 3000K	E	700 mA	36 V DC
8021696222615	QUICK 28W CRI80 3000K	E	700 mA	36 V DC
8021696222646	QUICK 28W CRI80 4000K	E	700 mA	36 V DC
8021696222639	QUICK 28W CRI80 4000K	E	700 mA	36 V DC

LEGENDA ICONE

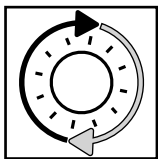

Sorgente luminosa sostituibile dall'utente finale.
 Replaceable light source by an end-user.

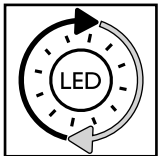

Sorgente LED luminosa sostituibile dall'utente finale.
 Replaceable LED light source by an end-user.

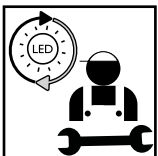

Sorgente luminosa sostituibile esclusivamente da personale autorizzato.
 Replaceable light source by authorized personnel only.

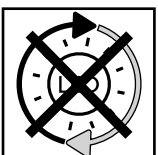

Sorgente luminosa non sostituibile. Quando la sorgente arriverà a fine vita dovrà essere sostituito l'intero apparecchio.
 Non-replaceable light source. Upon end of life of the light source, the whole product will be replaced.

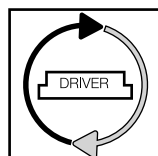

Dispositivo di alimentazione sostituibile dall'utente finale.
 Replaceable control gear by an end-user.

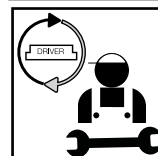

Dispositivo di alimentazione sostituibile esclusivamente da personale autorizzato.
 Replaceable control gear by authorized personnel only.

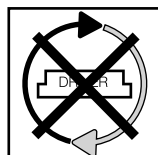

Dispositivo di alimentazione non sostituibile. Quando il dispositivo di alimentazione arriverà a fine vita dovrà essere sostituito l'intero apparecchio.
 Upon end of life of the control gear, the whole product will be replaced.

- 18.** Jei apsauginis stiklas yra įskilęs arba sudužęs, pakeiskite jį nedelsiant ir naudodami tik nuostatus atitinkančias keičiamas dalis.
- 19.** Šviesos šaltinis su nekeičiamais šviesos diodais (LED). Neišmontuokite gaminio, nes diodai gali pažeisti akis. Nejmerkite į vandenį. Valykite naudodami drėgną šluostę ir venkite stiprių tirpiklių ir ploviklių naudojimo.
- 20.** Prietaise įdiegtas lydysis saugiklis. Jei šviestuvą neįsijungia, pakeiskite lydųj saugiklį.
- 21.** I-ą elektros saugos klasę užtikrina bendra izoliacija bei apsauginis laidininkas (žeminimas) prijungtas prie metalinės šviestuvo dalies. Privalomas žeminimas
- 22.** II-ą elektros saugos klasę užtikrina bendra izoliacija ir dviguba izoliacija arba sustiprinta izoliacija. Žeminimas nėra būtinas.
- 23.** III-ą elektros saugos klasę užtikrina labai žemos įtampos maitinimas (mažesnis, nei 50 voltų). Žeminimas nėra būtinas.
- 24.** Neapsaugotas.
- 25.** Apsaugotas nuo kietųjų kūnų, kurių skersmuo didesnis, nei 50 mm. patekimo.
- 26.** Apsaugotas nuo kietųjų kūnų, kurių skersmuo didesnis, nei 12 mm. patekimo.
- 27.** Apsaugotas nuo kietųjų kūnų, kurių skersmuo didesnis, nei 2,5 mm. patekimo.
- 28.** Apsaugotas nuo kietųjų kūnų, kurių skersmuo didesnis, nei 1 mm. patekimo.
- 29.** Apsaugotas nuo dulkių patekimo.
- 30.** Visiškai apsaugotas nuo dulkių patekimo.
- 31.** Neapsaugotas.
- 32.** Apsaugotas nuo statmenai krentančių vandens lašų patekimo.
- 33.** Apsaugotas nuo vandens lašų, kurių kritimo didžiausias kampas yra 15°, patekimo.
- 34.** Apsaugotas nuo lietaus.
- 35.** Apsaugotas nuo vandens pūslių.
- 36.** Apsaugotas nuo vandens čiurkšlių.
- 37.** Apsaugotas nuo stiprių vandens čiurkšlių.
- 38.** Apsaugotas nuo laikino įmerkimo.
- 39.** Apsaugotas nuo įmerkimo tam tikram laikui.
- 40.** Prietaisas neturi būti uždengiamas šilumą izoliuojančia medžiaga.
- 41.** Dėmesio, elektros smūgio pavojus.
- 42.** Nežiūrėkite tiesiai į šviesos šaltinį.

